



TOP QUALITY PALLET TRUCK

- Top class range of pallet trucks with excellent designs
- Professional and ideal storage aid for all variety of manual transport tasks over short distances in stores and warehouse as well as factory plants.
- Reliable, sturdy, torsion-resistant due to its extremely strong high quality steel profile Germany standard WAGNER painting system ensures best powder coating and painting quality.
- All pivots points are greased ensures excellent maneuverability with effortless steering The chromed bearing bushes and joints ensure quiet running properties and particularly long service life.

Hand pallet truck

1KG=2.2LB 1INCH=25.4MM

Item/Type		AC20		AC25		AC30	
Capacity Q	kg	2000		2500		3000	
Min. fork height h	mm	85	75	85	75	85	75
Max. fork height h.	mm	200	190	200	190	200	190
Steering wheel	mm	Ø200x50	Ø180x50	Ø200x50	Ø180x50	Ø200x50	Ø180x50
Load roller Single	mm	Ø80x93	Ø74x93	Ø80x93	Ø74x93	Ø80x93	Ø74x93
Load roller Tandem	mm	Ø80x70	Ø74x70	Ø80x70	Ø74x70	Ø80x70	Ø74x70
Size of fork e's	mm	160x50				160x60	
Width overall forks B	mm	450/520/540/685					
Fork length l	mm	800/900/1000/1100/1150/1220					

Conforms to EN 1757-2

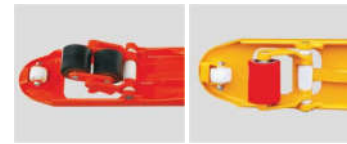

- Option of single and tandem fork rollers
- Additional entry and exit fork rollers guarantees for maximum stability and safety for transporting goods on slopes.



- Excellent galvanized whole casting hydraulic pump, robust and durable, with fine control of lowering speed and overload valve, low routine maintenance.

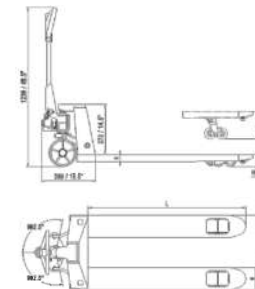

- Ergonomically designed handle with comfortable rubber grip allows the optimized safety as well as comfortable. Three position operational handle lever for lifting, transporting and lowering purposes
- Lower Position—to lower load, pull up on the finger tip control
- Neutral Position—to place finger tip control in this position during pulling the truck or load
- Lift Position—to raise load, push down on finger tip control, pump handle to raise the load



Hand Pallet Truck



- Option of different coating material for both steering wheel and fork rollers
- Polyurethane—Ideal for delicate floors with hard wearing and non-marking property, quiet and durable
- Nylon—low drag efforts, high resistance to chemicals, non-marking, preferred in food, fishing and chemical industries with smooth level floors.
- Rubber—Best choice for quiet and durable demands, ideal for smooth and rough floors.

Tandem fork rollers
 ---Ideal for heavy loads and uneven floors.

ER A20 & ER D20



The Easy Roller for Most Effortless Travelling Operations

INTRODUCTION

The Easy Roller makes with its mechanically powered drive travelling operations most effortless and safe.

Once the mechanically drive is engaged by oscillating up-and down- movements of the tiller the truck accelerates with a minimum of operational forces.

The function can be engaged to both direction and can be over driven. For safety in each opposite direction the drive works as a parking brake in one direction.

Horizontal transportation of heavy loads becomes easy and safe.



- **Robust and durable**
The trucks robust and durable design enlarges service intervals.
- **Short and maneuverable**
In most confined areas the truck makes the operations fast, safe and effortless.
- **Robust and durable pump with fine control of lowering speed, low maintenance.**
- **Options of tandem or single load wheels with entry rollers or not.**

▲ **Oscillation movements**
Easy oscillation movements of the tiller reduces the operational forces to a minimum.

▲ **Brake function and ramps**
If the mechanical drive is engaged in one direction, a brake function is applied into the other direction. On inclines this function is a obvious advantage: No downside rolling of the truck.

▲ This function also helps a lot if the truck is used on tail lifts or for battery exchange systems.



▲ **Mechanical Drive**
The mechanical drive for effortless acceleration with heavy loads. The drive can be engaged into both direction and has also a rest position.

▶ **Application Video**

Please find the application video for the Easy Roller at <http://www.noblelift.com>



Type		ER A20	ER D20
Load capacity	Q(t)	2.0	2.0
Service weight	kg	78 ¹⁾	72 ¹⁾
Tyre size, front	mm	180x50	180x50
Tyre size, rear (single/tandem)	mm	80x93/80x70 (74x93/74x70)	80x93/80x70 (74x93/74x70)
Wheels nr. front, rear		2/4	2/4
Fork height, Max.	h13(mm)	200(190)	200(190)
Height of tiller (max.)	h14 (mm)	1230	1230
Fork height, Min.	h3(mm)	85(75)	85(75)
Overall length	l1 (mm)	1600	1590
Fork dimensions	s/e/l (mm)	50/160/1150 ²⁾	60/160/1150 ²⁾
Distance between forks	b5 (mm)	540/ 685	540/ 685

¹⁾For truck 540x1150mm, with PU steer wheel and double PU fork rollers
²⁾L= 800/900/ 1000/ 1220/1500/1800 /2000mm optional

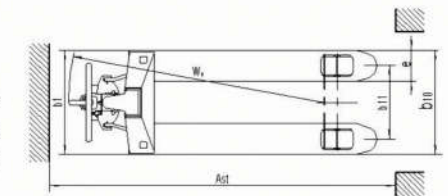
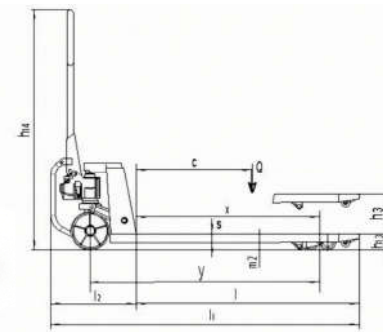

Hand Pallet Truck

NEW

UNIQUE DESIGN PALLET TRUCK

Perfect fluent outline of GiGA26 has many international and domestic patents.

Key components imported from Germany with best reliable quality, piston rod chrome plated with high wear resistance.

- Over-load protection valve enhances safety of the cargos and operator as well.
- Automatic slow-lowering system ensures the safety of the cargos, especially fragile cargos.
- Single-piece hydraulic valve cartridge has more advantages than scattered components such as easy maintenance, which is more preferred by the market.
- Rotating joints are equipped with Engineering Plastic Sliding Bearing, able to absorb eccentric load, with better wear resistance, extended using life and easy replacement.

Hand pallet truck		1KG=2.2LB 1INCH=25.4MM	
TECHNICAL DATA		GiGA26	
Load capacity	Q		2600
Dead weight		Kg	80kg(PU roller) or 76kg(Nylon roller)
Standard fork length	l	Kg	1150
Load centre distance	c	mm	600
Total length	L	mm	1540
Steering Wheels	diameter	mm	200 x 50
Tandem rollers		mm	80 x 70
Turning radius	Wa	mm	1335
Aisle width	A	mm	1790
Width over forks	b5	mm	540 / 685
Fork width	e	mm	160
Lowered height	h13	mm	85
Lifting height	h3	mm	200

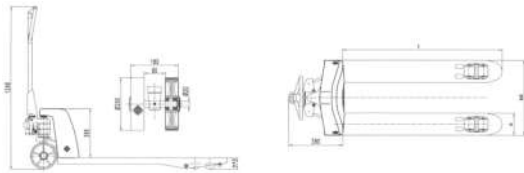

- Top class range of pallet trucks with excellent designs.
- Professional and ideal storage aid for all variety of manual transport tasks over short distances in stores and warehouse as well as factory plants.
- Reliable, sturdy, torsion-resistant due to its extremely strong high quality steel profile Germany standard WAGNER painting system ensures best powder coating and painting quality.
- All pivots points are greased ensures excellent maneuverability with effortless steering The chromed bearing bushes and joints ensure quiet running properties and particularly long service life.



- Ergonomically designed handle with comfortable rubber grip allows the optimized safety as well as comfortable.
- Lower Position—to lower load, pull up on the finger tip control
- Neutral Position—to place finger tip control in this position during pulling the truck or load.
- Lift Position—to raise load, push down on finger tip control, pump handle to raise the load.
- Excellent galvanized whole casting hydraulic pump, robust and durable, with fine control of lowering speed and overload valve, low routine maintenance.

EXCELLENT DESIGN PALLET TRUCK

Professional and ideal storage aid for all variety of manual transport tasks over short distances in stores and warehouse as well as factory plants.

Germany standard WAGNER painting system ensures best powder coating and painting quality.

- All pivots points are greased ensures excellent maneuverability with effortless steering
- The chromed bearing bushes and joints ensure quiet running properties and particularly long service life
- Optional quick lift function for ground clear lifting of pallets with only five pump actions.
- optional coating material like PU, Nylon and Rubber etc. for rollers and wheels meet different needs of customers and working ground and conditions.
- Ergonomically designed handle with comfortable rubber grip allows the optimized safety as well as comfortable.
- Three position operational handle lever for lifting, transporting and lowering purposes



WITH BEARING

Hand pallet truck		1KG=2.2LB 1INCH=25.4MM		
Item/Type		DELTA20	DELTA26	DELTA30
Capacity Q	kg	2000	2600	3000
Min. fork height h	mm	85	85	85
Max. fork height h ₁	mm	200	200	200
Steering wheel	mm	Ø200x50	Ø200x50	Ø200x50
Load roller Single	mm	Ø80x93	Ø80x93	Ø80x93
Load roller Tandem	mm	Ø80x70	Ø80x70	Ø80x70
Size of fork e's	mm	160x50		160x60
Width overall forks B	mm	450/520/540/685		
Fork length l	mm	800/900/1000/1100/1150/1220		

Conforms to EN 1757-2



Hand Pallet Truck

QUICKLIFT PALLET TRUCK

Quick lift pallet truck		1KG=2.2LB 1INCH=25.4MM	
Item/Type		ACF20H	ACF20L
Capacity Q	kg	2000	2000
Min. fork height h	mm	85	75
Max. fork height h ₁	mm	200	190
Steering wheel	mm	Ø200x50	Ø180x50
Load roller Single	mm	Ø80x93	Ø74x93
Load roller Tandem	mm	Ø80x70	Ø74x70
Size of fork e's	mm	160x50	
Width overall forks B	mm	450/520/540/685	
Fork length l	mm	800/900/1000/1100/1150/1220	

Lifting to Max.height: 5 times Conforms to EN 1757-2

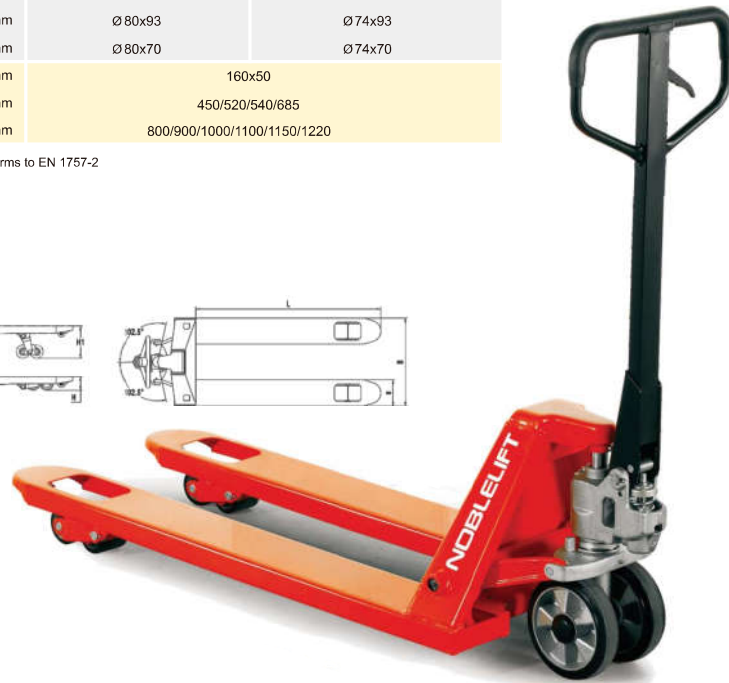
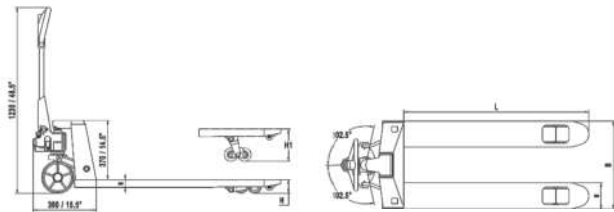

EXTRA WIDE OR LONG PALLET TRUCK

Super long or wide Pallet Truck		1KG=2.2LB 1INCH=25.4MM		
Item/Type		ACE20	ACL20	ACL35
Capacity (kg)	Kg	2000		3500
Min. fork height (mm)	mm	75/85		85
Max. fork height (mm)	mm	190/200		200
Steering wheel (mm)	mm	Ø180x50/Ø200x50		Ø200x50
Load roller Single	mm	Ø74x93/Ø82x93		Ø82x93
Load roller Tandem	mm	Ø74x70/Ø82x70		Ø82x70
Size of fork (mm)	mm	160X50	160X60	160X60
Width overall forks(mm)	mm	838 / 850/1000	540/685	540/685
Fork length (mm)	mm	1100/1150/1220	1500/1800/2000	1500/1800/2000

Conforms to EN 1757-2

- Diverse fork sizes on request such as 800, 900, 1000, 1150, 1220, 1500, 1800, 2000, 2500, 3000mm lengths and 520, 540, 685mm fork widths
- Maximum load capacity up to 3500kg

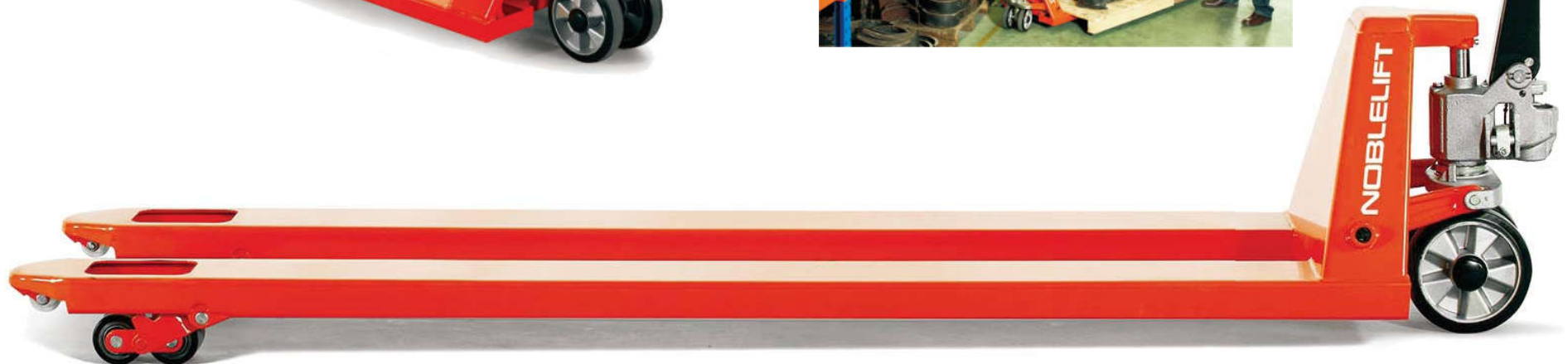

Hand Pallet Truck

PALLET TRUCK WITH HAND BRAKE

- Top class range of pallet trucks with excellent designs
- Reliable, sturdy, torsion-resistant due to its extremely strong high quality steel profile Germany standard WAGNER painting system ensures best powder coating and painting quality.
- All pivots points are greased ensures excellent maneuverability with effortless steering. The chromed bearing bushes and joints ensure quiet running properties and particularly long service life.



Hand pallet truck		1KG=2.2LB 1INCH=25.4MM			
Item/Type		AC20HB		AC25HB	
Capacity Q	kg	2000		2500	
Min. fork height h	mm	85	75	85	75
Max. fork height h ₁	mm	200	190	200	190
Steering wheel	mm	Ø200x50	Ø180x50	Ø200x50	Ø180x50
Load roller Single	mm	Ø80x93	Ø74x93	Ø80x93	Ø74x93
Load roller Tandem	mm	Ø80x70	Ø74x70	Ø80x70	Ø74x70
Size of fork e*s	mm	160x50			
Width overall forks B	mm	450/520/540/685			
Fork length l	mm	800/900/1000/1100/1150/1220			

Conforms to EN 1757-2



REEL CARRYING PALLET TRUCK

Roll Pallet Truck		1KG=2.2LB 1INCH=25.4MM			
Item/Type		AC20R500	AC20R700	AC20R1000	AC20R1500
Capacity Q	kg	2000			
Reel diameter	mm	400-600	600-800	800-1200	1200-1600
Width overall forks B	mm	760	850	1000	1150
Steering wheel	mm	Ø200x50			
Load roller Single	mm	Ø80x93			
Load roller Tandem	mm	Ø80x70			
Fork length l	mm	800/900/1000/1100/1150/1220			

Conforms to EN 1757-2

"Reel Carrying Truck" designed for carrying horizontal transport loads such as rolls, reels, cable drums etc.



Excellent galvanized whole casting hydraulic pump, robust and durable, with fine control of lowering speed and overload valve, low routine maintenance.

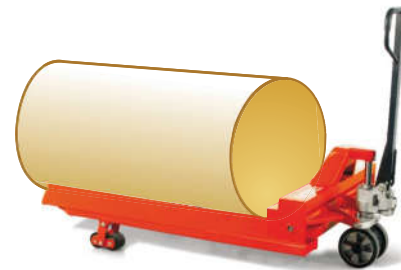

- Ergonomically designed handle with comfortable rubber grip allows the optimized safety as well as comfortable. Three position operational handle lever for lifting, transporting and lowering purposes.
- Lower Position—to lower load, pull up on the finger tip control
- Neutral Position—to place finger tip control in this position during pulling the truck or load
- Lift Position—to raise load, push down on finger tip control, pump handle to raise the load

LOW PROFILE PALETT TRUCK



Low-profile Pallet Truck(51MM/35MM)		1KG=2.2LB 1INCH=25.4MM	
Item/Type		AC-Low-51mm	AC-Supper Low
Capacity Q	kg	1500	1000
Min. fork height h	mm	51	35
Max. fork height h ₁	mm	165	90
Steering wheel	mm	Ø180x50	Ø160x50
Load roller Single	mm	Ø50x93	
Load roller Tandem	mm	Ø50x70	Ø34x58
Size of fork e*s	mm	160x37	160x30
Width overall forks B	mm	540/685/838	530/685
Fork length l	mm	1150/1220	1120

Conforms to EN 1757-2

- Easy access to the lowest pallets and containers with the minimum floor clearance of 35mm and 51mm only.
- Your handy choice to handle the low pallets which can only be handled by counterbalanced forklifts.

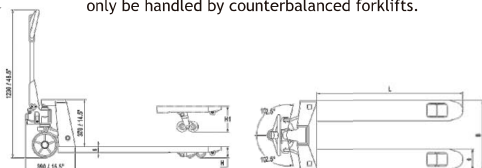

FOUR-WAY PALETT TRUCK

- Unique 4-directional hand pallet truck
- Special 4-directional movement capability provides the flexibility to maneuver wide loads through standard aisles.
- The additional set of wheels allows pallet truck to be moved sideways in addition to the conventional forward and back directions.
- With all the features and quality of our AC model standard hand pallet truck

SideRoller Pallet Truck		1KG=2.2LB 1INCH=25.4MM	
Capacity Q	kg	1500	
Min. fork height h	mm	85	
Max. fork height h ₁	mm	85-170-210	
Steering wheel	mm	Ø200x50	
Load roller Single	mm	Ø78x70	
Load roller Tandem	mm	Ø65x60	
Size of fork e*s	mm	160x50	
Width overall forks B	mm	540	685
Fork length l	mm	1100/1150/1220	
Remarks Normal transportation	mm	85mm-170mm,2500kg	
Remarks Transverse transportation	mm	170mm-210mm,1500kg	

Conforms to EN 1757-2



Hand Pallet Truck



Ideal transport aid for application in damp or harsh environments such as meat or fish processing plants, dairies, pharmaceutical and chemical industry.



GALVANIZED PALLET TRUCK

- All the exposed parts of the whole truck galvanized, including hydraulic pump, fork frame, handle and so on.
- Special application in cold and wet environments resists the effects of cold, condensation and washing.
- Nylon steering wheel and fork rollers as standard option for damp or harsh environments applications.
- With pressure relief valve and overload valve to prevent pump damages when loads exceed weight limits.
- The one-piece pump design simplifies repairs, assuring reliable service and long life.

Galvanized pallet truck		1KG=2.2LB 1INCH=25.4MM	
Item/Type		ACZ20H	ACZ20L
Capacity Q	kg	2000	2000
Min. fork height h	mm	85	75
Max. fork height h ₁	mm	200	190
Steering wheel	mm	Ø200x50	Ø180x50
Load roller Single	mm	Ø80x93	Ø74x93
Load roller Tandem	mm	Ø80x70	Ø74x70
Size of fork e*s	mm	160x60	
Width overall forks B	mm	520/540/685	
Fork length l	mm	1100/1150/1220	

Conforms to EN 1757-2

STAINLESS PALLET TRUCK

Stainless pallet truck		1KG=2.2LB 1INCH=25.4MM	
Item/Type		ACS20H	ACS20L
Capacity Q	kg	2000	2000
Min. fork height h	mm	85	75
Max. fork height h ₁	mm	200	190
Steering wheel	mm	Ø200x50	Ø180x50
Load roller Single	mm	Ø80x93	Ø74x93
Load roller Tandem	mm	Ø74x70	Ø74x70
Size of fork e*s	mm	160x60	
Width overall forks B	mm	520/540/685	
Fork length l	mm	1000/1100/1150/1220	

Conforms to EN 1757-2

- All metal parts made completely stainless steel, including hydraulic pump, fork frame, handle and so on.
- Ideal transport aid for application in damp or harsh environments such as meat or fish processing plants, dairies, pharmaceutical and chemical industry.
- With pressure relief valve and overload valve to prevent pump damages when loads exceeds weight limits.
- The enclosed fork tips (for Aisi316 stainless truck only) ensure there is no dead corner where corrosive spatters remains and damages the truck.
- Specially designed for applications where hygiene is of utmost importance.
- Nylon steering wheel and fork rollers as standard option for damp or harsh environments applications.



Hand Pallet Truck

STAINLESS STEEL TRUCK WITH WEIGHT INDICATION

Our stainless steel weighing pallet truck allows you to weigh your load on the spot for maximum efficiency. The frame uses heavy-duty steel AISI#304 stainless steel construction for maximum strength and durability. The rugged and effective weighing pallet truck are idea for customers working in food or chemical industries need weighing applications during transportation. The built-in scale allows you to weigh your load as you are handling it.



Hand pallet truck		1KG=2.2LB 1INCH=25.4MM	
Item/Type		ACSW20S	ACSW20L
Capacity Q	kg	2000	2000
Min. fork height h	mm	85	85
Max. fork height h ₁	mm	195	195
Size of fork e*s	mm	542x1150	687x1220
Big wheel	mm	180*50	180*50
Front wheel	mm	74*70	74*70
Net Weight	kg	110	115
Packaging		4	4
Packaging size	mm	2250x550x650	2250x700x650
Net weight/Gross weight	kg	110/460	115/480
Pcs/20' container		120	96

Technical Indicators

- 6-digit 1.2-inch LED display, 7 state indicator lamps. Long service life and shock resistance
- 7 function keys. Operation is simple and convenient
- Protection level: IP5x
- Excitation voltage: +5VDC
- Load capacity of sensor: at most 4 350Ω simulation sensors
- Input signal range of null point: 0-5mV
- Input signal range of full scale: 1-10 mV
- Inner resolution: 1 million
- Weight upgrading rate: 40 times per second
- Power supply mode
 - Battery: 6V4Ah
 - Adapter: voltage 100-240VAC Current 0.1A Frequency 50-60Hz.
- 2 RS232 ports
- Operating temperature: -10°C-40°C, relative humidity is below 85 %

Main Function

- Basic weighing function: resetting, removing the peel and clearing the peel
- Weight detection function, counting function, animal scale function
- Weight keeping function, weight accumulation function, percentage display
- Set redundant backup function of parameters
- Automatic screen protection and automatic shutdown energy-saving function
- Rich printing formats and communication protocol



Hand Pallet Truck

NEW

HEAVY DUTY PALLET TRUCK

Top class range of pallet trucks with excellent designs

Professional and ideal storage aid for all variety of manual transport tasks over short distances in stores and warehouse as well as factory plants.

- Reliable, sturdy, torsion-resistant due to its extremely strong high quality steel profile Germany standard WAGNER painting system ensures best powder coating and painting quality.
- All pivots points are greased ensures excellent maneuverability with effortless steering The chromed bearing bushes and joints ensure quiet running properties and particularly long service life.



Heavy duty maintenance free pump with excellent service performance, Optional quick lift function for ground clear lifting of pallets with only five pump actions.

1KG=2.2LB 1INCH=25.4MM				
Item/Type		CBG	CBG/QL20H(Quick lift)	CBG/QL20L(Quick lift)
Capacity Q	kg	2000/2500	2000	2000
Min. fork height h	mm	85/75	85	75
Max. fork height h ₁	mm	200/190	200	190
Steering wheel	mm	∅200x50/∅180x50	∅180x50/∅200x50	∅180x50
Load roller Single	mm	∅80x93/∅74x93	∅80x93	∅74x93
Load roller Tandem	mm	∅80x70/∅74x70	∅80x70	∅74x70
Size of fork e's	mm	160x60or150x50	160x60or150x50	160x60 or150x50
Width overall forks B	mm	520/550/685	520/550/685	520/550/685
Fork length l	mm	800/900/1000/1100/1150/1220	800/900/1000/1100/1150/1220	800/900/1000/1100/1150/1220

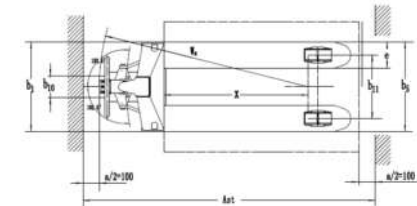
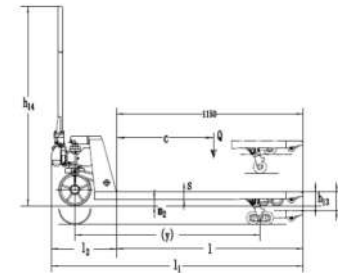

- Option of different coating material for both steering wheel and fork rollers
- Polyurethane—Ideal for delicate floors with hard wearing and non-marking property, quiet and durable
- Nylon—low drag efforts, high resistance to chemicals, non-marking, preferred in food, fishing and chemical industries with smooth level floors.
- Rubber—Best choice for quiet and durable demands, ideal for smooth and rough floors.

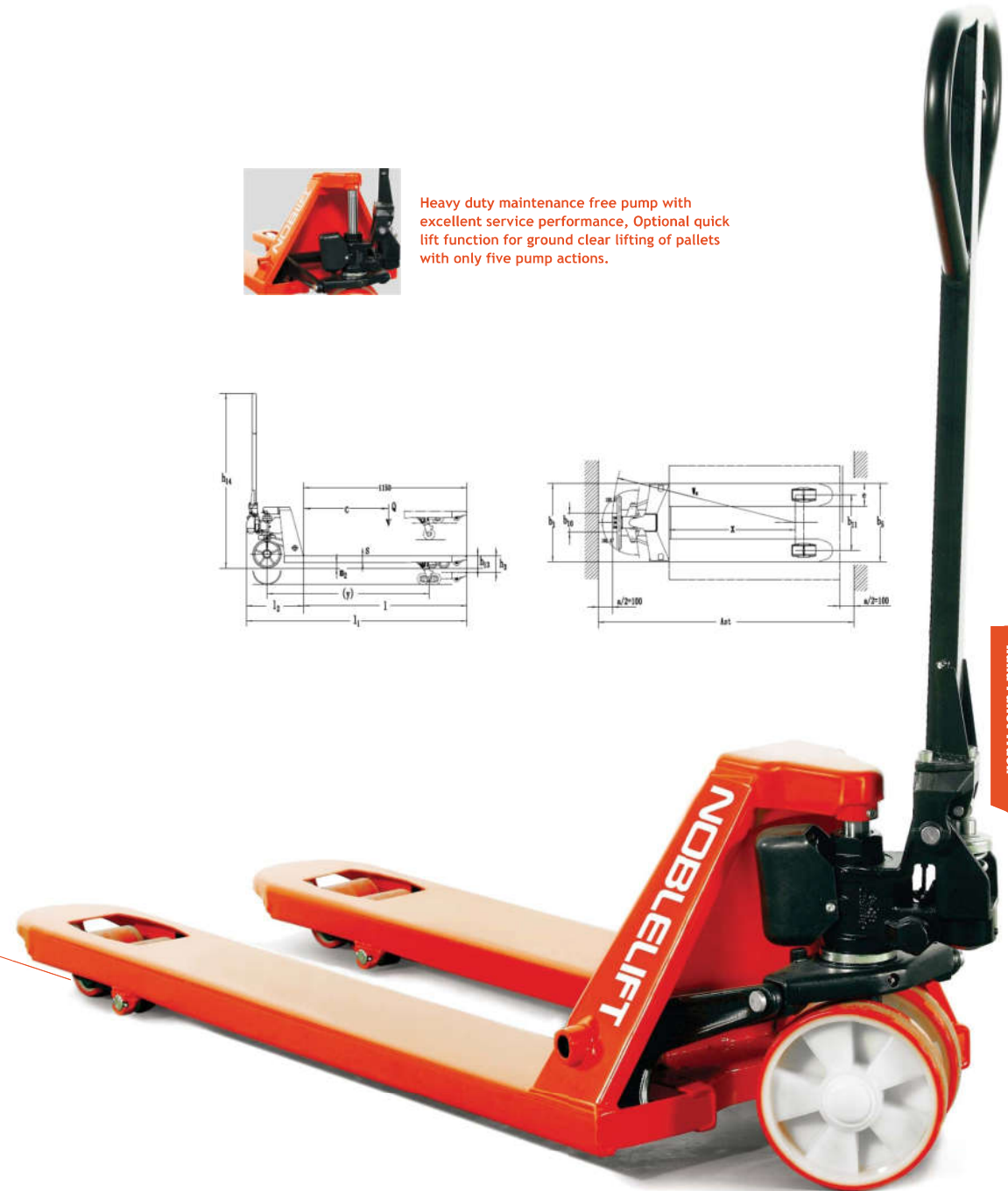

Hand Pallet Truck

STANDARD PALLET TRUCK

- Professional and ideal storage aid for all variety of manual transport tasks over short distances in stores and warehouse as well as factory plants.
- Compact and attractive design with maximum loading capacity of 2000–3000kg
- Germany standard WAGNER painting system ensures best powder coating and painting quality.
- All pivots points are greased ensures excellent maneuverability with effortless steering
The chromed bearing bushes and joints ensure quiet running properties and particularly long service life.

Hand Pallet Truck

1KG=2.2LB 1INCH=25.4MM

Item/Type		DF20		DF25		DF30	
Capacity Q	kg	2000		2500		3000	
Min. fork height h	mm	85	75	85	75	85	75
Max. fork height h ₁	mm	200	190	200	190	200	190
Steering wheel	mm	Ø200x50	Ø180x50	Ø200x50	Ø180x50	Ø200x50	Ø180x50
Load roller Single	mm	Ø80x93	Ø74x93	Ø80x93	Ø74x93	Ø80x93	Ø74x93
Load roller Tandem	mm	Ø80x70	Ø74x70	Ø80x70	Ø74x70	Ø80x70	Ø74x70
Size of fork e*s	mm	160x60					
Width overall forks B	mm	450/520/550/685					
Fork length l	mm	800/900/1000/1100/1150/1220					

Conforms to EN 1757-2

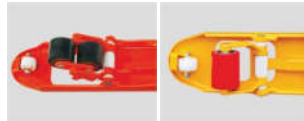

Option of single and tandem fork rollers
Additional entry and exit fork rollers guarantees for maximum stability and safety for transporting goods on slopes.



LIGHT DUTY PALLET TRUCK

- Compact hydraulic pump design, robust and durable, with fine control of lowering speed and overload valve, low routine maintenance.
- Ergonomic handle shape, robust and durable

Light-duty hand pallet truck, only for special markets

Item/Type		DF168
Capacity Q	kg	1680
Min. fork height h	mm	75
Max. fork height h ₁	mm	190
Steering wheel	mm	Ø180x50
Load roller Single	mm	Ø73x80
Load roller Tandem	mm	Ø73x55
Size of fork e*s	mm	150x50
Width overall forks B	mm	520/550
Fork length l	mm	1150
N.W.	kg	50-55.5

1KG=2.2LB 1INCH=25.4MM

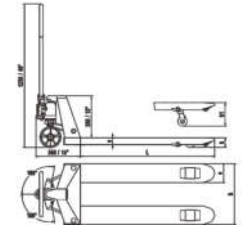
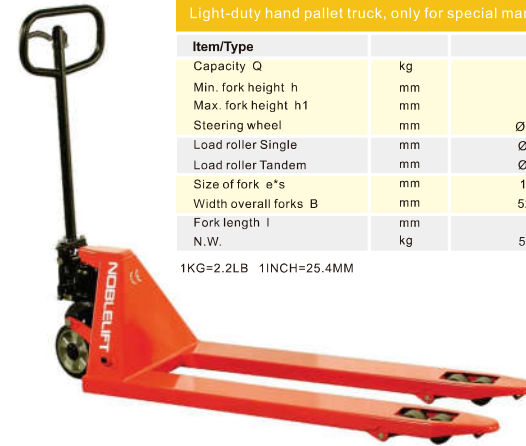

Mini-hand-pallet-truck
Economic, handy & reliable

ECONOMIC PALLET TRUCK

Economic but reliable

1KG=2.2LB 1INCH=25.4MM

Item/Type		DFE20
Capacity Q	kg	2000
Min. fork height h	mm	75
Max. fork height h ₁	mm	190
Steering wheel	mm	Ø180x50
Load roller Single	mm	Ø73x80
Load roller Tandem	mm	Ø73x55
Size of fork e*s	mm	150x50
Width overall forks B	mm	520/550/685
Fork length l	mm	1150/1220
N.W.	kg	50-60

- Economic but reliable
- Professional and easy to operate
- Diverse options for rollers, wheels and fork dimensions as well as colors and etc

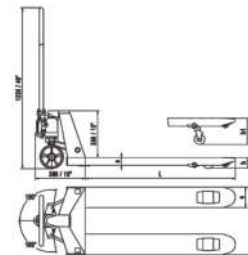

Hand Pallet Truck



HEAVY DUTY PALLET TRUCK

1KG=2.2LB 1INCH=25.4MM

Item/Type		L series	L60/SL (Low Profile)
Capacity Q	kg	2000/2500/3000	1500
Min. fork height h	mm	75	47
Max. fork height h ₁	mm	185	155
Steering wheel	mm	Ø200/180x50	Ø180x50
Load roller Single	mm	Ø74x93	
Load roller Tandem	mm	Ø74x70	Ø44x70
Size of fork e*s	mm	177x45	177x35
Width overall forks B	mm	520/550/685	520/685/838
Fork length l	mm	800/900/1000/1100/1150/1220	1150/1220

Conforms to EN1757-2

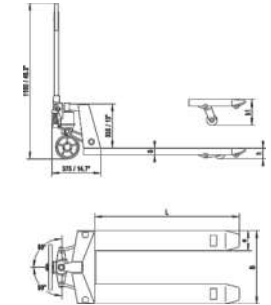

- Germany standard WAGNER painting system ensures best powder coating and painting quality.
- All pivots points are greased ensures excellent maneuverability with effortless steering The chromed bearing bushes and joints ensure quiet running properties and particularly long service life.



- Option of different coating material for both steering wheel and fork rollers
- Polyurethane—Ideal for delicate floors with hard wearing and non-marking property, quiet and durable
- Nylon—low drag efforts, high resistance to chemicals, non-marking, preferred in food, fishing and chemical industries with smooth level floors.
- Rubber—Best choice for quiet and durable demands, ideal for smooth and rough floors.



Compact and attractive design with maximum loading capacity of 2000-3000kg

Hand Pallet Truck

PALLET TRUCK WITH WEIGHT INDICATION

The HP ESE20/5 is built on the head of a completely standard hand pallet truck, which makes it different from all conventional pallet truck scales: the single fork structure contains no scale components and the forks keep their original dimensions.

Capacity: 2000 kg in 5 kg steps
 Scale functions: zero correction, total weight
 Electronic lifting height indication in display
 Power supply: 2 standard 1.5V AA / LR6 batteries
 Possible to reach 3,000 weightings on a set of batteries
 Original fork dimensions
 Splash proof: IP65



Only 2 keys needed for operation
 New: Totalization function!

Indicator powered by two AA batteries (2x1.2-1.5V), which are located behind a sealed cover



Schematic exploded view of product configuration



The “First weight indication system with electronic height indication” the ESE20/5 is used and assembled on a standard, normal and traditional hand pallet truck... one single chassis needed only .. and that makes the big difference with all other traditional hand pallet trucks with scales, which need systematically a double chassis.

		1KG=2.2LB 1INCH=25.4MM	
Item/Type		ESE20	ESE20
Capacity(kg) Q		2000	
Load Center(mm) C		400/450/500/550/600/610	
Wheel Base(mm) Y		763/863/963/1063/1113/1183	
Min. fork height(mm) h13		85	75
Max. fork height(mm) h1		200	195
Handle Height(mm) h14		1233	1223
Steering wheel(mm)		Ø200x50	Ø180x50
Load roller (mm) D1	Single	Ø80x93	Ø74x93
	Tanden	Ø80x70	Ø74x70
Fork Size(mm)		160x50	
Fork Overall width(mm) b5		450/520/540/685	
Fork length(mm) l		800/900/1000/1100/1150/1220	
Overall length(mm) l1		1192/1292/1392/1492/1542/1612	
Turning radius(mm) Wa		915/1015/1115/1215/1265/1335	
Battery		DC 1.5Vx2	

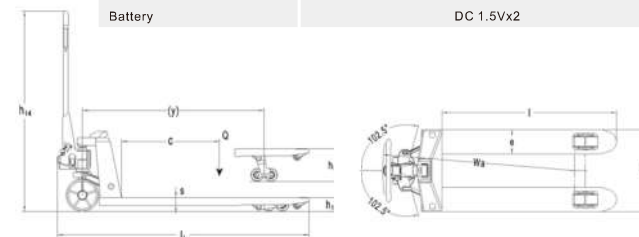

WEIGHING SCALE PALLET TRUCK

High accuracy

Maximum error 0.1% of scale capacity, even with floor conditions that are not optimal or when a load is placed out of centre. The accuracy remains high.

Totalising function

Add up multiple pallet weights to a total weight per shipment or order, also for avoiding overloads. When weight is added, the display shows the new total weight and the number of pallets weighed. This permits the user to verify that he did not forget to weigh any pallets or weighed the same pallet twice.

High battery autonomy

Four standard AA-batteries (2.7Ah) allow 70 hours of use. The automatic sleep mode assures that 4200 weighting actions can be taken. In most common use this means that batteries will have to be changed* only one time per year (*or charged if rechargeable batteries are used).

High contrast display

Display can be read from any angle: when operator is standing near the pallet for dosing, or for adding products to the pallet by weight. The display does not need a backlight because it reads extremely well at ambient light conditions.

Big function keys that "click"

When pushing the function keys, the operator senses a "click" movement. Even when working with gloves, the operator feels whether he has pressed the key properly.



OPTIONAL:

Thermal Printer
Printer which is reliable in mobile applications. Use of printer does hardly influence the life time of the batteries. The printer is protected for use at low battery voltage levels. The printer is also resistant to vibrations and shocks.



HP-ESRP



	1KG=2.2LB 1INCH=25.4MM	
Item/Type	HP ESRP20	HP ESR20/L
Capacity(kg)	2000	2000
Min.fork height(mm) H1	85	76
Max.fork height(mm) H2	200	190
Steering wheel(mm) D	Ø180×50	Ø180×50
Load roller (mm) D1	Single	
	Tanden	Ø74×70
Size of fork (mm) C×H	182×50	182×50
Width overall forks (mm) B		555/692
Fork length (mm) A		1150/1220
Overall length A1		1580/1650
Battery		DC 1.5V×4

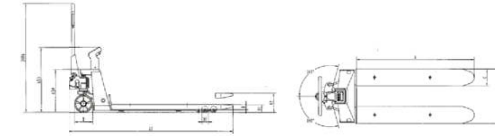

Water and dust proof to norm IP65

One of the most important characteristics for a reliable mobile scale. IP65 means that the pallet truck scale can be used outside or on lorries and be cleaned with water (but not by high pressure !!!) The load cells in the forks have an even higher protection level.

Pallet truck with scale

Capacity: 2000kg in 1 kg steps

Tolerance: +/- 2 kg

Scale functions: zero correction, gross/net weighing, total weight

Power supply: 4x1.5V AA batteries

Low battery warning + auto shut off function after 3 minutes

Total fork width 570mm, width per fork 180mm, fork height 90mm, fork length 1150mm

Polyurethane steering wheels and tandem fork rollers

Hand Pallet Truck

PALLET TRUCK WITH BOX GUARD

- 48x27" box guard adapts to a variety of cargo sizes and shapes to keep loads stable.
- Prevents accidental lifting of second pallet by lowering frame guard and reducing length by 9".
- Holds cargo in place to ensure safety.



AC25/BG

PALLET TRUCK WITH FOOT PEDAL

- Foot pedal gives you the option of using the foot pedal to raise the forks.
- when space constraints make it difficult to use the standard handle to raise the load.
- Foot pedal folds out of the way when not in use.



Pallet Truck with Box Guard 1KG=2.2LB 1INCH=25.4MM

Model		AC25/BG	DF25/BG
Capacity	kg	2500	2500
Fork Height Max.	mm	190	190
Fork Height Min.	mm	75	75
Width Across Forks	mm	685	685
Width Between Forks	mm	365	365
Fork Length	mm	1220	1220
Fork Width	mm	160	160
Overall Length	mm	1610	1610
Overall Width	mm	685	685
Overall Height	mm	1220	1220
Main Wheel Size	mm	180	180
Wheel Material		Mold-on Polyurethane	Mold-on Polyurethane
Roller Dia.	mm	74	74

DF25/BG



Pallet Truck--Foot and Hand Actuated 1KG=2.2LB 1INCH=25.4MM

Model		DF25/FT
Capacity	kg	2500
Fork Height Max.	mm	190
Fork Height Min.	mm	75
Width Across Forks	mm	685
Width Between Forks	mm	365
Fork Length	mm	1220
Fork Width	mm	160
Overall Length	mm	1700
Overall Width	mm	685
Overall Height	mm	1220
Main Wheel Size	mm	180
Wheel Material		Mold-on Polyurethane
Roller Dia.	mm	74

SLS10/15 MANUAL STAINLESS STEEL SCISSOR LIFT PALLET TRUCK

1. Unique one cylinder system guarantees: no risk of old leakage, no risk of dropping to the second piston.

2. Ergonomically designed handle with comfortable rubber grip allows the optimized safety as well as comfort, Three position operational handle lever for lifting, transporting and lowering purposes.

SLS		1KG=2.2LB 1INCH=25.4MM	
Item/Type		SLS10	SLS15
Capacity	kg	1000	1500
Min. fork height	mm	85	85
Max. fork height	mm	800	800
Size of fork	mm	160x50	160x50
Width of overall fork	mm	540/680	540/680
Length of fork	mm	1150	1150
Fork roller	mm	80x70	80x70
Big wheel	mm	180x50	180x50
Weight	kg	120/125	125/130



SLS10E/15E ELECTRIC STAINLESS STEEL SCISSOR LIFT PALLET TRUCK

1. Come with maintenance-free 60AH battery and built-in smart charger, loads can be lifted both manually and electrically.

2. Position your height quickly and effortlessly at the push of the button when working at frequently changing heights.

SLSE		1KG=2.2LB 1INCH=25.4MM	
Item/Type		SLS10E	SLS15E
Capacity	kg	1000	1500
Min. fork height	mm	85	85
Max. fork height	mm	800	800
Size of fork	mm	160x50	160x50
Width of overall fork	mm	540/680	540/680
Length of fork	mm	1150	1150
Fork roller	mm	80x70	80x70
Big wheel	mm	180x50	180x50
Battery V/Ah		12V/60AH	12V/60AH
Lifting motor power		0.8KW	0.8KW
Weight	kg	155/160	160/165



MANUAL SCISSOR LIFT PALLET TRUCK

■ Ergonomically designed scissor lift pallet truck or called work positioner can lift and place your materials at the most productive working height safest for the worker, preventing back injuries caused by bending and lifting.

■ Designed to raise open-bottom pallets to proper working height with support legs deploy automatically to ensure operator safety.

■ Single cylinder for robustness and less maintenance.

Single Cylinder Manual Scissor Lifter			
Model		MSL10	
Capacity	Kg	1000	
Min. fork height	mm	85	
Max. fork height	mm	800	
Lifting stroke (unloaded)		28	
Lifting stroke (loaded)		70	
Width across forks	mm	540	680
Fork width	mm	160	
Fork length	mm	1170	
Front wheel Dia.	mm	Ø75X50	
Big wheel Dia.	mm	Ø180X50	
Overall length	mm	1738	
Overall width	mm	579	719
Overall height	mm	1266	
Net weight	Kg	109	
4 Units Package size	cm	214X62X111	214X76X111
Quantity for 20' container		72	64



ELECTRIC SCISSOR LIFT PALLET TRUCK

■ Available in Manual Pump or Battery Operated models (complete with 12V/50A maintenance-free AGM battery with built-in charger that plugs into any outlet). All models also available in 540mm or 680mm width configuration.

Single Cylinder Scissor Pallet Truck			
Model		ESL10	
Capacity	Kg	1000	
Min. fork height	mm	85	
Max. fork height	mm	800	
Lifting stroke (unloaded)		15S	
Lifting stroke (loaded)		25S	
Lowering speed		0.1m/s	
Width across forks	mm	540	680
Fork width	mm	160	
Fork length	mm	1170	
Front wheel Dia.	mm	Ø75X50	
Big wheel Dia.	mm	Ø180X50	
Overall length	mm	1738	
Overall width	mm	579	719
Overall height	mm	1285	
Net weight	Kg	134	
4 Units Package size	cm	214X62X111	214X76X111
Quantity for 20' container		72	64
Battery (Gel)	Weight	15.2Kg	
	Size	224X135X175mm	
	V/Ah	12V/50Ah	
Lifting Motor		12V/800W	



Hand Pallet Truck
NEW

SCISSOR LIFT PALLET TRUCK

Scissor lift pallet truck design to load and unload conveyor, feed presses, or any applications requiring moving and positioning pallets or containers of materials.

- Equipped with quick lift function doubles the lift speed for loads lighter than 200kg.
- With pressure relief valve and overload valve to prevent pump damages when loads exceeds weight limits.
- The enclosed fork tips and reinforced fork frames ensures long service life.

Hand Scissor Lift Pallet Truck		1KG=2.2LB	1INCH=25.4MM	
ITEM \ TYPE		HLT10	HLT15	HLT(N)10
Capacity Q	Kg	1000	1500	1000
Min. fork height h	mm	85	85	85
Max. fork height h ₁	mm	800	800	800
Size of fork exs	mm	162x50	162x50	162x50
Length of fork l	mm	1140	1100	1150
Width overall fork (adjust/fixed) b5	mm	520/680	520/680	540/680
N.W.	Kg	105/112	118/125	128/133
Fork rollers	mm	Ø75x50	Ø75x50	Ø75x50
Big wheel	mm	Ø150x50	Ø150x50	Ø180x50
Dimension of wooden crate	mm	1930x590x720/ 1930x740x720	1930x590x720/ 1930x740x720	2040x600x1110/ 2040x740x1110
Pcs/20' container	mm	120/96	120/96	72/64

Note: HLT10&HLT15 is two-cylinder-system
HLT(N)10 is one-cylinder-system



ELECTRIC SCISSOR LIFT PALLET TRUCK

Powered by 12 voltage battery, driven by a good effective pump station. Used as both a work table and pallet truck 10-12 seconds pumping from the bottom to the top.



Electric Scissor Lift Pallet Truck				
		1KG=2.2LB	1INCH=25.4MM	
Model	Lifting Capacity(kg)	Lowest Fork Height(mm)	Max Fork Height(mm)	Fork Length X Fork Width(mm)
DGB1500	1500	85	800	1100×520 1100×680
DGB1000	1000	85	800	1140×520 1140×680
	Dia. of front wheel(mm)	Dia. of rear wheel(mm)	Lifting time in full range(s)	Size of Fork(mm)
DGB1500	Ø75x50	Ø150x50	18	162×50
DGB1000	Ø75x50	Ø150x50	10/12	162×50
	Descending Speed(mm/s)	Motor working voltage(v)	Battery voltage(v)	Electricity volume(AIhour)
DGB1500	<0.1	12	12	63
DGB1000	<0.1	12	12	63
	Working pressure of Pump Station(Mpa)	Input/output voltage of Charger(v)	Max charging current of charger(A)	
DGB1500	21	AC230/115DC12	10	
DGB1000	15	200-240/12	10	

- Safety overload system prevents the truck from being used beyond its rated capacity.
- The handle automatically returns to its upright position when released.
- Lifting motor power 1.1KW.

TWO-CYLINDER SCISSOR LIFT PALLET TRUCK

With pressure relief valve and overload valve to prevent pump damages when loads exceeds weight limits.

Nylon steering wheel and fork rollers as standard option for damp or harsh environments applications.



Stainless Scissor Lifter		
		1KG=2.2LB 1INCH=25.4MM
TYPE	SLP10	SLP15
capacity	1000	1500
fork width(W)	540	680
fork length(L)	1150	1150
min.fork height(H)	85	85
Max. fork height	800	800
front wheel	PU/Nylon 80*50	
rear wheel	PU/Nylon 180*50	
net weight	110	125



- The INOX version of Scissor lift pallet truck is designed for corrosive environments or applications with high standards of hygiene where the goods need to be handled at a convenient working height.
- Ideal transport aid for application in damp or harsh environments such as meat or fish processing plants, dairies, pharmaceutical and chemical industry as transport aid as well as working table.

STAINLESS SCISSOR LIFT PALLET TRUCK

Stainless Scissor Lifter	
1KG=2.2LB 1INCH=25.4MM	
TYPE	SLP10-INOX
capacity	1000
fork width(W)	540
fork length(L)	1150
min.fork height(H)	85
Max. fork height	800
front wheel	PU/Nylon 80*50
rear wheel	PU/Nylon 180*50
net weight	110

The ACX 10M / ACX 10E is the manual and electric scissor lift pallet truck with 2200lbs capacity and 31 1/2 inch maximum lifting height; designed to be used to work as a lifting table, marshalling table, work bench or as a standard hand pallet truck.

1KG=2.2LB 1INCH=25.4MM

Single Cylinder Manual Scissor Lifter			
Model		ACX 10M	
Capacity	kg	1000	1000
Fork Height Raised	mm	800	800
Fork Height Lowered	mm	85	85
Fork Length	mm	1170	1170
Fork Width	mm	160	160
Width Across Forks	mm	540	680
Width Between Forks	mm	200	370
Caster Dia.	mm	180	180
Caster Material		Polyurethane	Polyurethane
Overall Length	mm	1730	1730
Overall Width	mm	585	710
Overall Height	mm	1270	1270

SCISSOR LIFT PALLET TRUCK

- Closed fork tips and reinforced chassis ensure high lifetime.
- Ergonomically designed and comfort-able handle with higher grip casing.
- Single cylinder for robustness and less maintenance.

ELECTRIC SCISSOR LIFT PALLET TRUCK

1KG=2.2LB 1INCH=25.4MM

Single Cylinder Electric Scissor Lifter			
Model		ACX 10E	
Capacity	kg	1000	1000
Fork Height Raised	mm	800	800
Fork Height Lowered	mm	35	35
Fork Length	mm	1170	1170
Fork Width	mm	160	160
Width Across Forks	mm	540	680
Width Between Forks	mm	200	370
Caster Dia.	mm	180	180
Caster Material		Polyurethane	Polyurethane
Overall Length	mm	1730	1730
Overall Width	mm	585	710
Overall Height	mm	1270	1270

- Optional emergency button.
- Optional deep discharge protection.

MANUAL SKID LIFTER

- The Skid Lifters are a unique combination of lift table and pallet truck.
- Ideally suited for direct mail organizations and companies involved in printing to load and unload large bundles of envelopes, magazines and trays of materials.
- Captured scissors roller provides greater stability in raised position.
- Lowered height provides easy access to skids, tote boxes, wire container and much more.



Manual					
1KG=2.2LB 1INCH=25.4MM					
Model		4ZD60	2MNW5	4ZD59	2MNW6
Capacity	kg	500	500	1000	1000
Fork Height Raised	mm	830	830	830	830
Fork Height Lowered	mm	85	85	85	85
Fork Length	mm	1120	1120	1120	1120
Fork Width	mm	160	160	160	160
Width Across Forks	mm	680	520	680	520
Width Between Forks	mm	360	200	360	200
Caster Dia.	mm	152	152	152	152
Caster Material		Polyurethane	Polyurethane	Polyurethane	Polyurethane
Caster Type		2 Swivel, 2 Rigid	2 Swivel, 2 Rigid	2 Swivel, 2 Rigid	2 Swivel, 2 Rigid
Overall Length	mm	1550	1550	1640	1640
Overall Width	mm	740	570	710	560
Overall Height	mm	1070	1070	1270	1270



Hand Pallet Truck

ELECTRIC SKID LIFTER

Powered units provide easier and faster lifting.

Electric		
1KG=2.2LB 1INCH=25.4MM		
Model		2MNW7
Capacity	kg	1000
Fork Height Raised	mm	876
Fork Height Lowered	mm	85
Fork Length	mm	1120
Fork Width	mm	160
Width Across Forks	mm	680
Width Between Forks	mm	360
Caster Dia.	mm	152
Caster Material		Polyurethane
Caster Type		2 Swivel, 2 Rigid
Overall Length	mm	1770
Overall Width	mm	710
Overall Height	mm	1270

